

Installation instructions for PZ4AL-03870-00

Toyota Camry

Under Run Protective Shield engine bay and transmission case



Model Year: 2001

Vehicle Code:

Part Number: PZ4AL-03870-00



Weight: 9.85 kg



Installation Time: 25 min

A

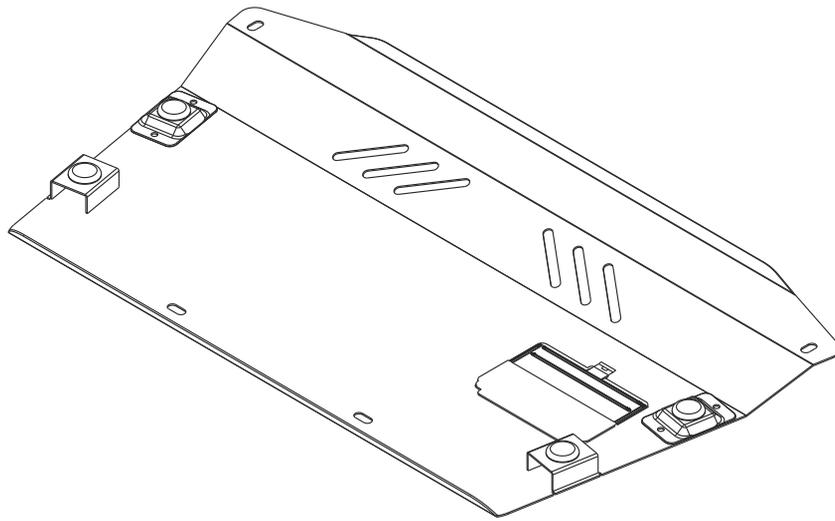

PZ4AL- 03870- 60

B

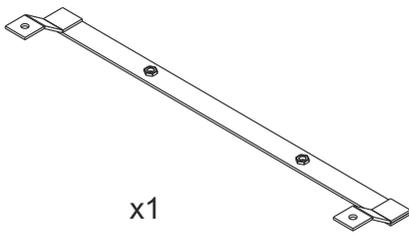

x1

C

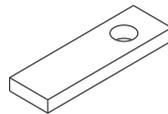

x4

D

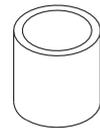

x2

E

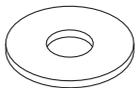

6x Ø10

F1



2x M 10x20

F2



4x M 10x60

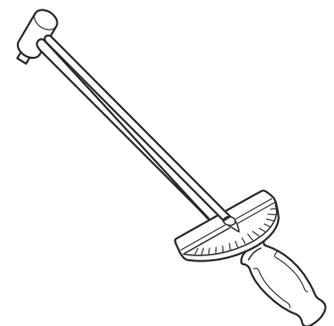
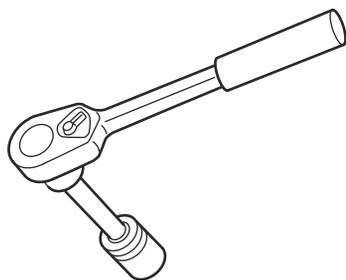

1

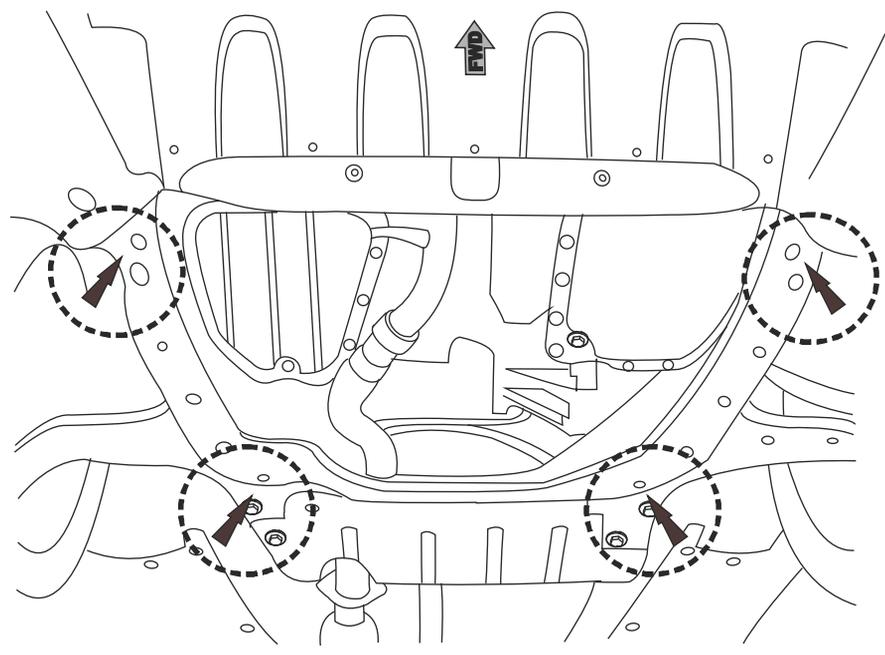

2

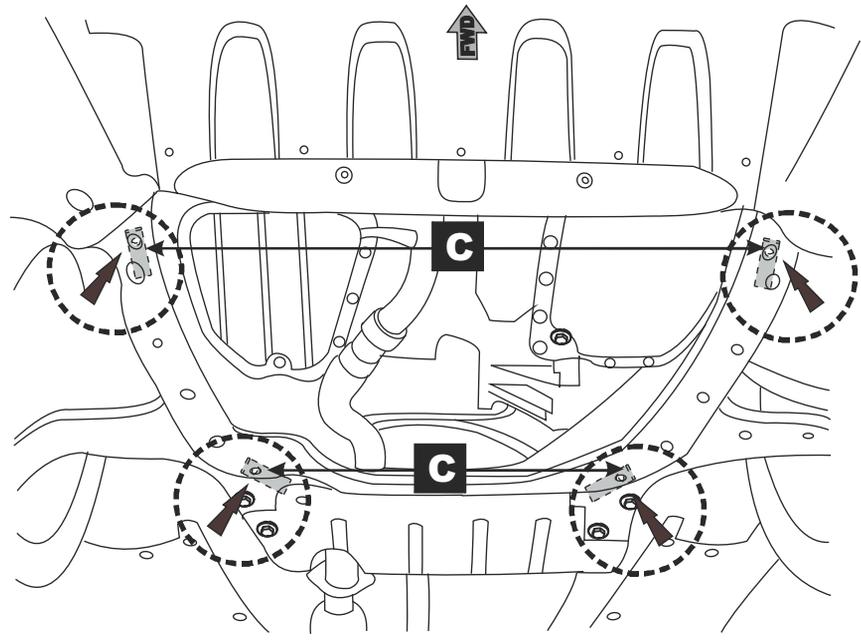

3

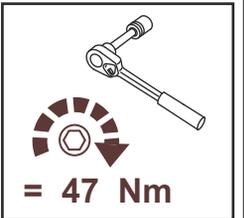
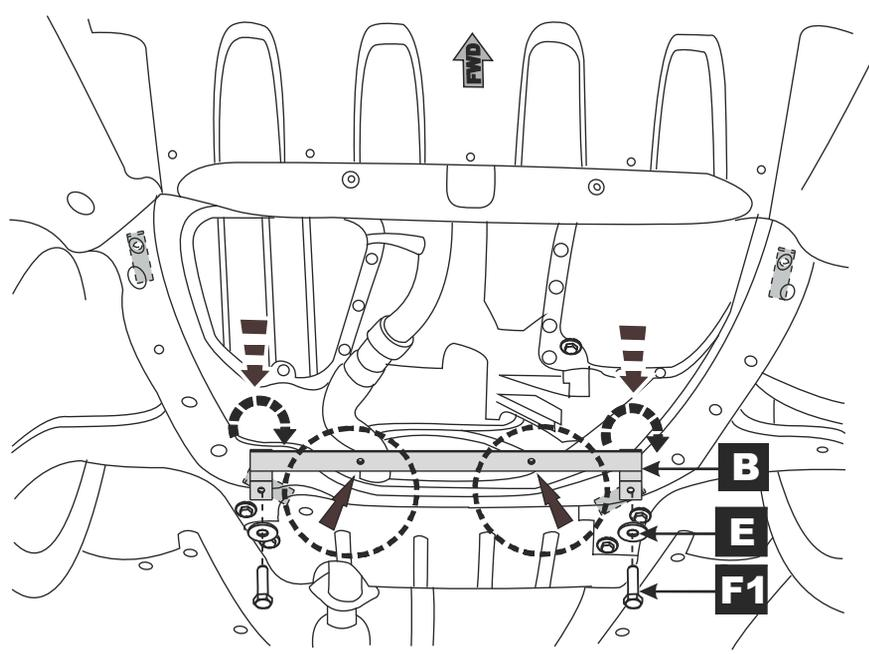

4

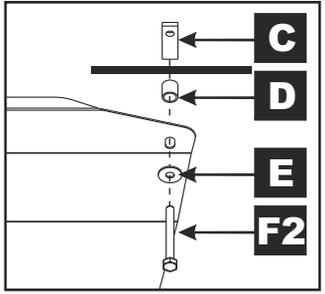
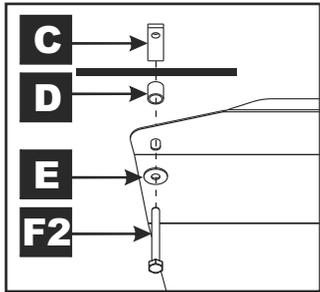
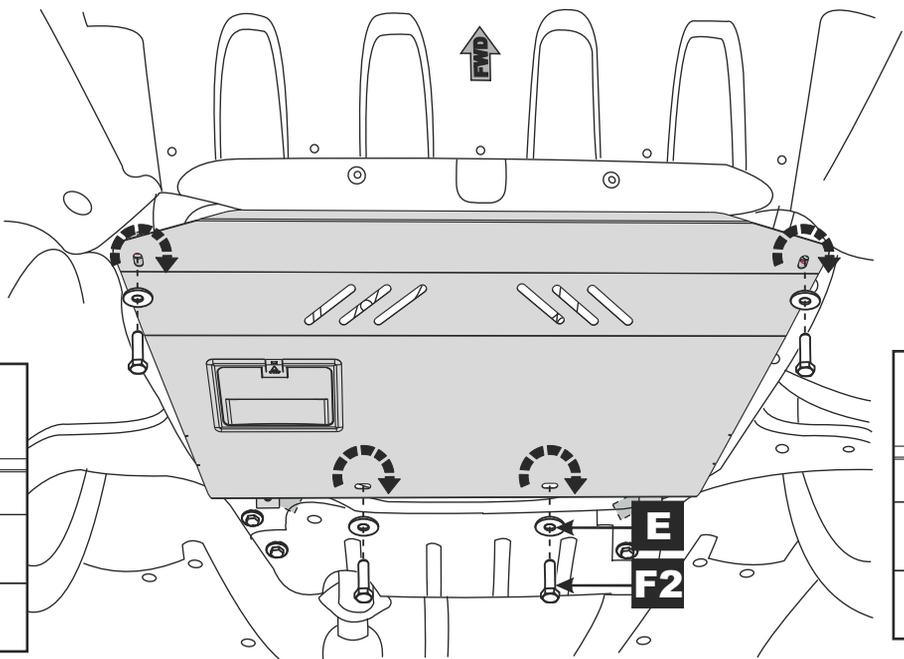

5

